

CAUTION

Before beginning installation read all general guidelines, special notes and installation steps thoroughly and be sure to check and follow all your local building codes. Failure to do so may result in improper installation and may void the homeowner's warranty.

ALWAYS WEAR SAFETY GLASSES

TOOLS NEEDED Hammer, circular saw, chalk line, utility knife or snips, tape measure, caulking gun & roofing sealant.

GENERAL GUIDELINES FOR RIDGEMASTER PLUS AND HIPMASTER

1. All RidgeMaster Plus & Hip Master series use the same specs.
2. RidgeMaster Plus can be used only for ridge installations, NOT for hip areas. For hip installations you MUST use HipMaster. HipMaster can also be used for ridge installations, for example, with wood and dimensional shingles.
3. RidgeMaster Plus and HipMaster must be used with an equal or greater amount of soffit ventilation, see "How To Calculate Proper Ventilation" on bottom of Page 4.
4. IMPORTANT: Always use nails long enough (2 1/2" – 3") to completely penetrate roof sheathing by at least 1/4". This applies to installing both ridge vent and cap shingles. 3" nails are available from a distribution partner (sold separately).
5. All slot cut-outs should end 12" from outside walls, chimneys, ridge corners or hip joints. HIP ROOF NOTE: Hip slots should start halfway up the roof hip and end 36" from the top of the hip, unless joining up to a ridge vent, in which case hip slot cut-outs can end 12" from ridge. In order to maintain maximum structural integrity, hip slot cut-outs should be no more than 24" long and spaced about 12" apart, see illustration A below.
6. RidgeMaster Plus must always extend 10" – 12" beyond slot at beginning and end of ridge. For optimal roofline appearance run RidgeMaster Plus and HipMaster along entire ridge and hip line to the terminal ends of the roof as shown in illustration B below. If there is no ridge to join up to, HipMaster should extend 36" beyond its slots in both directions.
7. RidgeMaster Plus and HipMaster each have an overlap and an underlap end that interlock when laid end to end in the proper orientation. This joins the 4 foot sections into a single, structurally integrated, weathertight system. Always start installing RidgeMaster with overlap end on outside terminal end of ridge. (See illustration E on page 2 for identification of RidgeMaster Plus overlap end). Important: Complete your ridge vent installation with a factory end on the opposite terminal end of the ridge. See Steps 11 and 12 on page 3 for this technique.
8. Baffles on underside of vents must always sit flush on flat part of shingle surface and not extend into slot area, see illustration F on page 2. To prevent weather penetration through gaps and ridges in architectural or dimensional shingles, baffles must sit flush on upper flat part of shingle not on raised dimensional part. This may require trimming the shingle and repositioning it in the RidgeMaster Plus baffle area to maintain continuous baffle contact with a flat surface, see step 10 on page 3. Failure to sit baffles properly could result in leakage of snow or water.

NOTE: These instructions are designed to meet most typical residential and commercial applications. However, no installation manual can cover all individual situations. For special situations and applications, please contact the manufacturer.

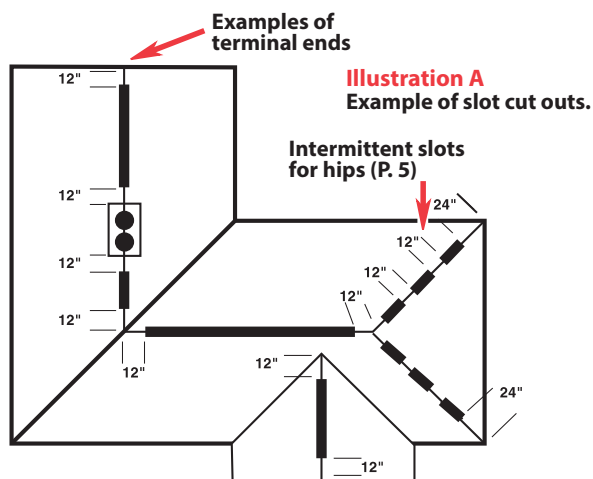

Slot cut outs (shown in black above) should stop 12" short of terminal ends and chimneys. Hip slots should be cut intermittently and begin half way up hip, stopping 12" from ridge if joining up to a ridge vent and 36" if there is no ridge vent to join up to.

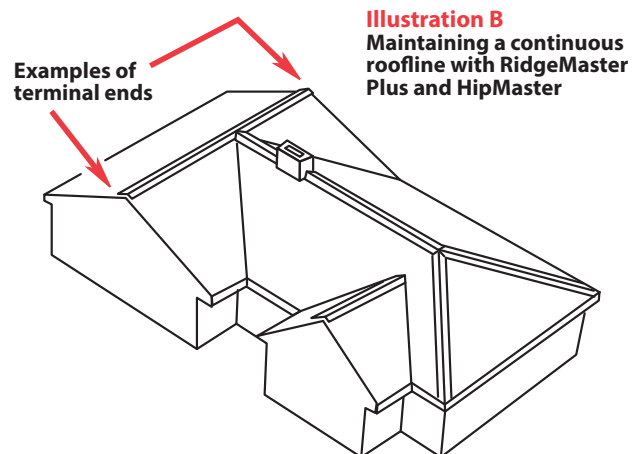

All vents should extend beyond slots, but, for optimal appearance, extend ridge and hip vents to terminal ends of roof and join them where they meet. This creates a continuous roof line and an aesthetically pleasing look.

Illustration C

Truss roofs (No ridge boards)

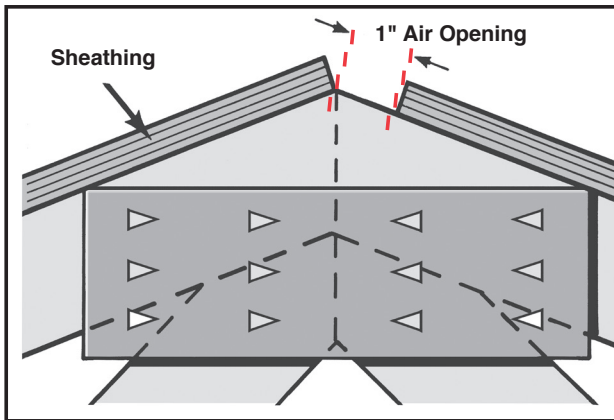

Plywood sheathing on truss roofs can be laid 1" short on one side at ridge or you may leave 1/2" air opening on each side of center for a 1" total air opening. Any larger sized opening will not improve ventilation. REMEMBER: Baffles must always be in complete contact with flat surface and not overlap slot.

Illustration D

Rafter Framed roofs with ridge pole

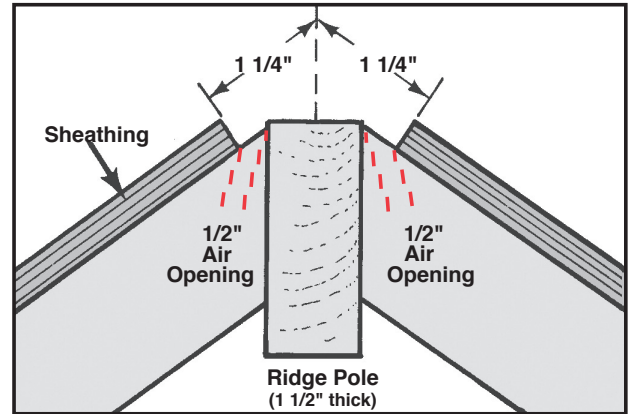

Cuts should be made to expose a 1/2" air opening between sheathing and each side of ridge pole. Any larger sized opening will not improve ventilation. RidgeMaster Plus & HipMaster = 12.228 sq. in. per lineal foot—Net Free Ventilation. See page 4 also.

NOTE: RidgeMaster Plus 9" and HipMaster 9" use the same specifications as RidgeMaster Plus 11" and HipMaster 11" with the exception of accepting 9" cap shingles instead of 11".

Illustration E

RidgeMaster Plus & HipMaster*

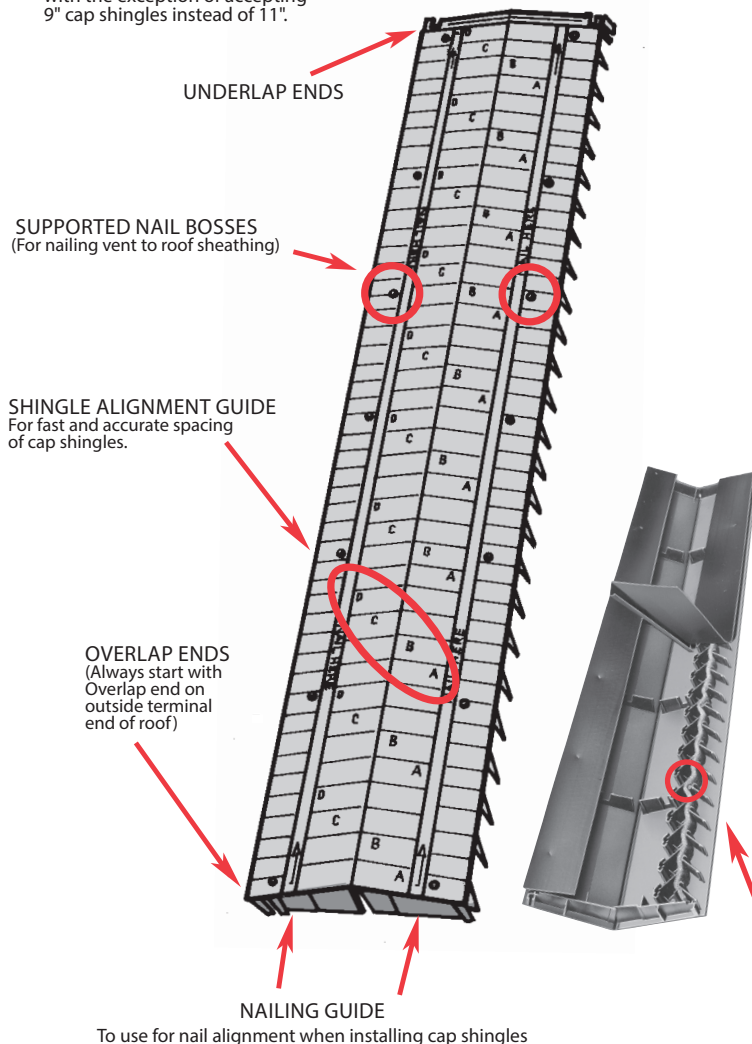
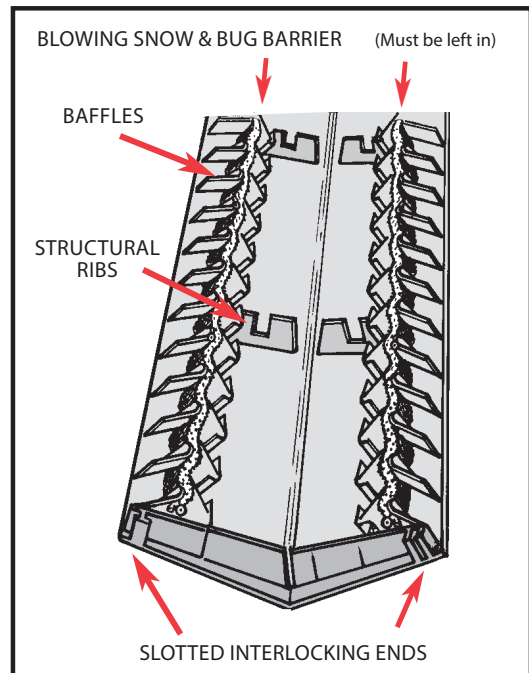
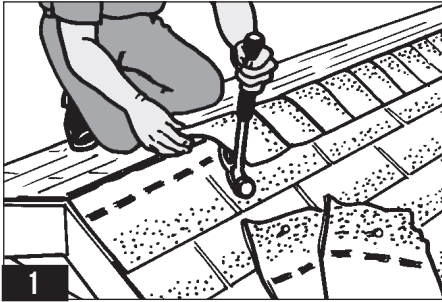

Illustration F

RidgeMaster Plus and HipMaster*



*HipMaster has an added baffle underneath—not shown above.



1 For retrofitting, remove existing cap shingles from roof. For new construction, start with Step 4.

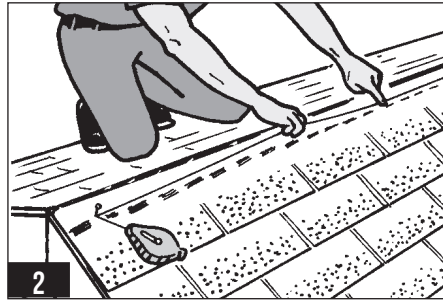

2 For ridge pole construction, determine a point that will expose a 1/2" air slot on each side of ridge pole. You may want to use a chalk line as a cutting guide. For truss roofs, see illustration C on page 2.

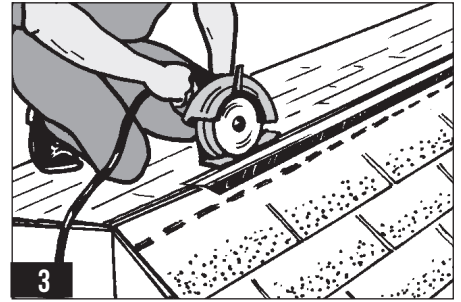

3 Use a circular saw to cut roof substrate along chalk line. Begin slots 12" from end of outside wall under roof. See Illustration A on page 1. Adjust saw depth so you don't cut rafters. Watch for nails when cutting.

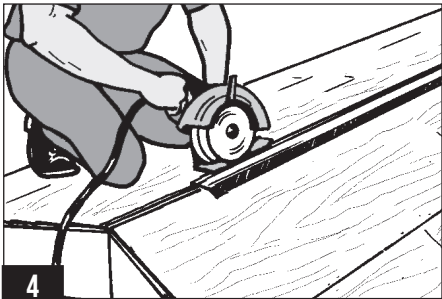

4 For new construction cut slots or set back plywood, then shingle roof so top course of shingles ends with flat area of shingle at ridge.

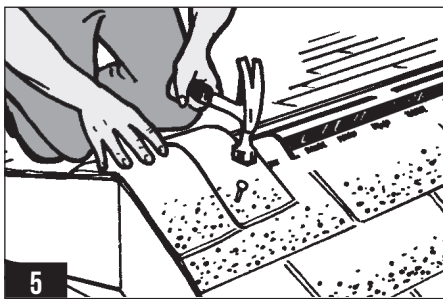

5 Install a minimum of two ridge cap shingles at all the terminal ends of the roof.

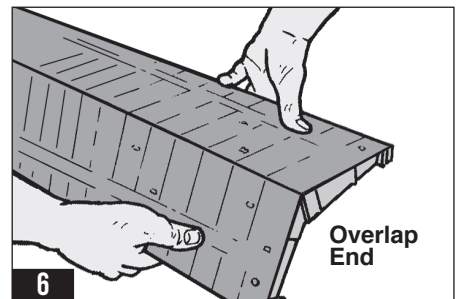

6 Flexing RidgeMaster Plus to preform the pitch makes installation easier. **IMPORTANT:** Always start with overlap end on outside terminal end of roof.

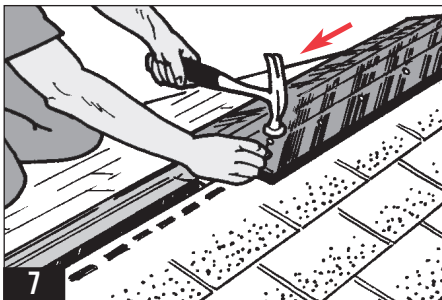

7 Start 2" from one end and begin nailing Overlap end of RidgeMaster Plus to roof. Nail through supported Nailing Bosses, see illustration E on page 2.

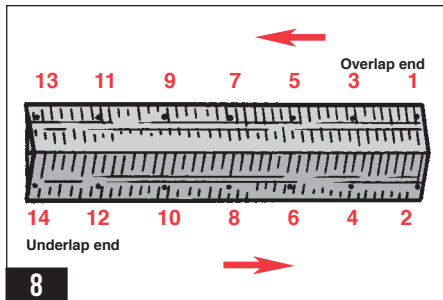

8 Recommended nailing sequence is to start from one end of vent and work to the other end alternating sides and nailing completely as you go. Keep vent shaped evenly or baffles will not sit flush on roof.

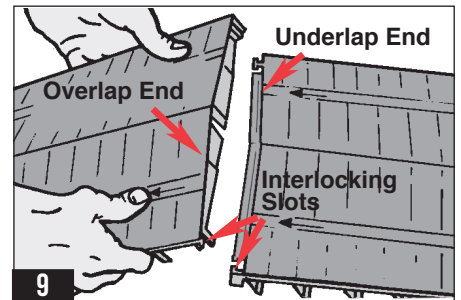

9 RidgeMaster Plus joins together with Overlap and Underlap slotted interlocking ends to resist weather and insect infiltration. No caulking is necessary at these joints.

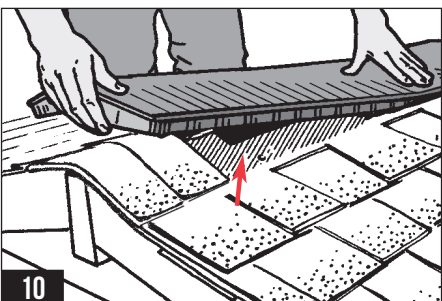

10 **IMPORTANT:** With laminated or architectural type shingles, the baffles on the underside of the vent must sit flush on flat part of shingles as shown and not on dimensional ridges and gaps part of shingle.

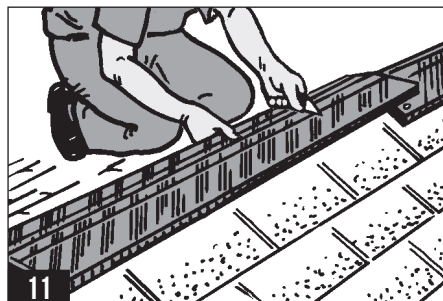

11 To end your ridge vent installation follow this procedure. If last piece of RidgeMaster Plus needs to be cut because it is too long, measure length to be cut, add 1/2" to measurement and cut off squarely with knife.

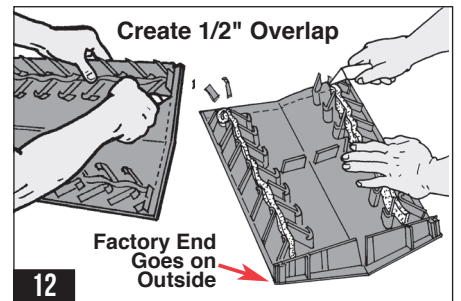

12 Create 1/2" Overlap. Knife back baffles on cut end about 1/2" to create an over-lap end. Join handmade end to last piece of vent installed making factory end the outside terminal end and finish by nailing to roof.

RIDGEMASTER PLUS INSTALLATION

ALWAYS WEAR SAFETY GLASSES

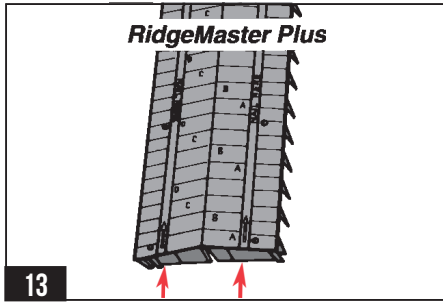

13 To nail cap shingles in place, use nail guide provided on vent labeled "Nail Here." See illustration above. Make sure nails penetrate all the way through the vent and the roof sheathing by a minimum of 1/4".

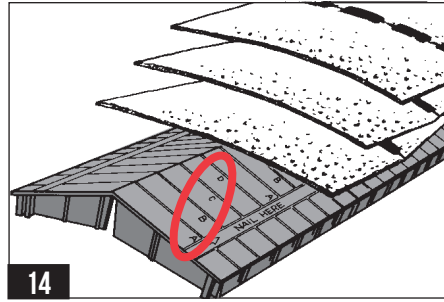

14 RidgeMaster Plus uses built in Shingle Alignment Guides to evenly space and square 11" cap shingles on vent. RidgeMaster Plus 9" and HipMaster 9" follow same guides but use 9" caps.

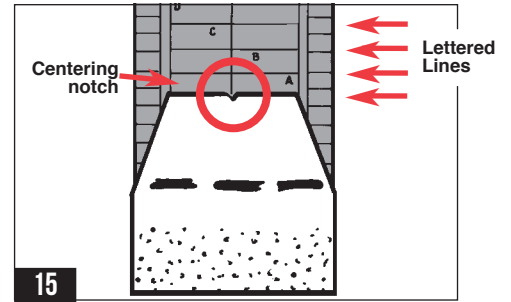

15 To ensure perfectly square placement of cap shingles align centering notch on back of shingle with center line along top of RidgeMaster Plus. Align back of shingle with horizontal lettered lines.

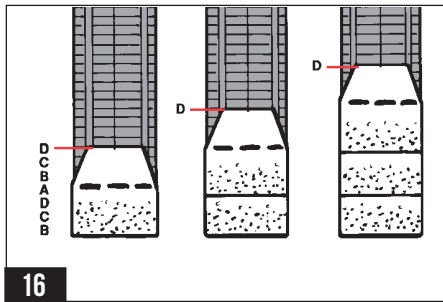

16 To evenly space cap shingles on RidgeMaster Plus, note whatever lettered line the back of your first shingle falls on then use the same lettered line for all the cap shingles. See line "D" in illustration above.



17 Nail all cap shingles in place using nails long enough to completely penetrate roof sheathing by 1/4".

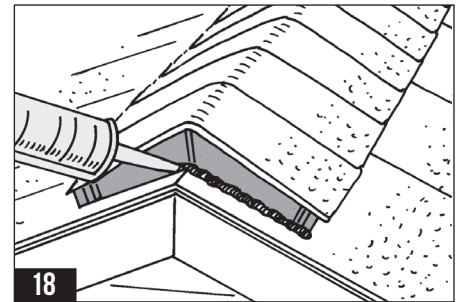

18 To complete installation, apply a good quality roof sealant to the outside terminal ends of RidgeMaster Plus where it meets the roof.

HOW TO CALCULATE PROPER VENTILATION

International Residential Code (IRC R 806.2 min. vent area) = 1 sq. ft. of ventilation for every 300 sq. ft. of attic space with 50% in ridge and 50% in soffit.

RidgeMaster, RidgeMaster Plus and HipMaster = 12.228 sq. in. per lineal foot—Net Free Ventilation

EXAMPLE: 2,000 sq. ft. attic

- 40' x 50' = 2,000 sq. ft. attic.
- 2000 sq. ft./300 sq. ft. = 6.67 sq. ft. (total ventilation req.)
- 6.67 x 144 = 960 sq. in. (Conversion to inches)
- 960 sq. in. = 480 sq. in. (Ridge) + 480 sq. in. (Soffit)
- Add 20% on roofs 7/12–11/12
- Add 30% on roofs 12/12 or greater

A 50' ridge with RidgeMaster installed equals approximately 600 sq. in. of ventilation.

(More than industry standards)

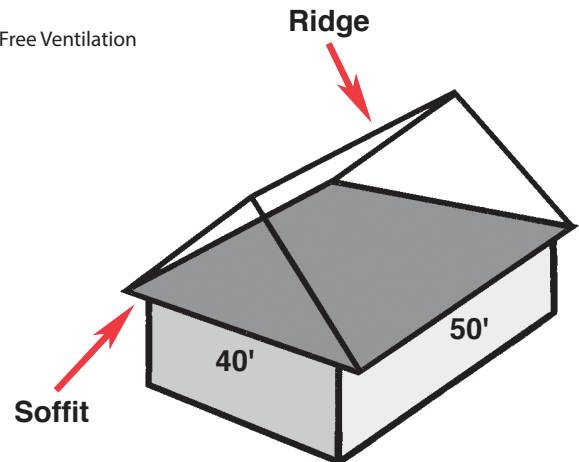

CAUTION

Before beginning installation read all general guidelines, special notes and installation steps thoroughly and be sure to check and follow all your local building codes. Failure to do so may result in improper installation and may void the homeowner's warranty.

ALWAYS WEAR SAFETY GLASSES

1. Make sure you use HipMaster on hips of roofs ONLY. RidgeMaster Plus is NOT designed for hip areas.
2. At top of hip, join HipMaster with RidgeMaster Plus where possible.
3. Slot Cut-Outs: It is not recommended to cut one continuous slot for hips. Proper ventilation and strength can best be obtained with intermittent cuts. Initial cuts should start halfway up the roof hip and end 12" from top of hip when joined with RidgeMaster Plus, 36" from top of HipMaster when not joining to ridge. See Steps 5–6 below and illustration A, page 1.
4. CAUTION: HipMaster must always be installed with the arrows on all vents pointing up towards the top of the roof. Failure to do so will result in leakage, see Step 9 below.
5. A generous amount of roofing sealant must be applied where the flat underside of the baffle on HipMaster contacts the roof in order to fill the gaps between the vent and the shingles that step down the roof, see Step 8.



If retrofitting, remove existing cap shingles from ridge and hip. New construction—skip Step 1.

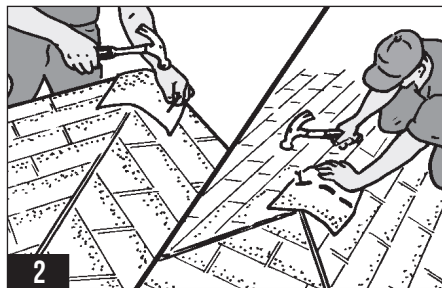

Install a minimum of two cap shingles at the bottom of each hip and at the terminal ends of each ridge if you will be installing RidgeMaster Plus along with HipMaster.



If your roof has a ridge, install RidgeMaster Plus along entire ridge from hip joint to hip joint. See RidgeMaster Plus installation, but do not install ridge cap shingles on top at this time.



Snap two parallel chalk lines 2 1/2" apart along entire hip (1 1/4" on each side of center). Cutting away shingles on these lines with a roofing knife will make following steps easier.

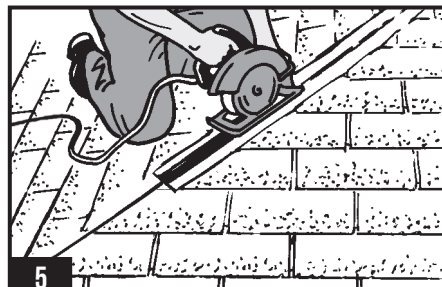

Cut slots on chalk lines starting halfway up roof hip & ending 12" from top when joining with ridge. See next step for cutting pattern. See illustration D page 2 for slot air opening guidelines.

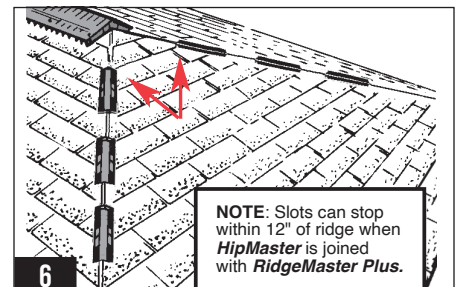

For hips, one continuous slot is not recommended. To maintain maximum roof strength, hip slots should be approximately 2 feet in length, be spaced 1 foot apart and extend halfway down the hip. Set saw depth to cut only sheathing not rafters.



Begin installing HipMaster from the bottom of the hip.

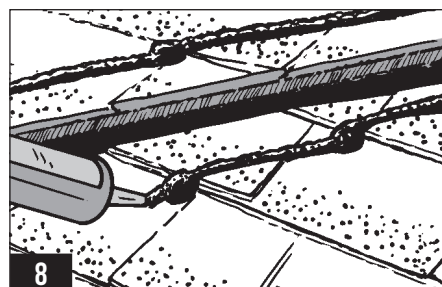

Before installing each vent apply roofing sealant in a line parallel to slot and 3/4" away from it. Add generous amounts at low points particularly with dimensional shingles.

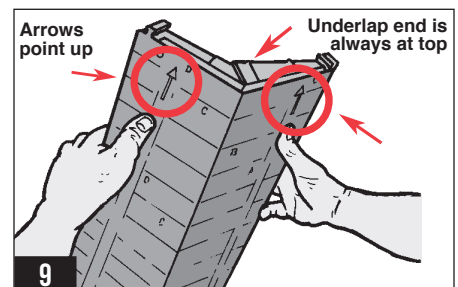

IMPORTANT: When installing HipMaster, make sure arrows on all hip vents point up towards top of roof and Underlap end is at top. Failure to do so will result in leakage.



Lay HipMaster in position making sure there is good contact with roofing sealant. Ensure that all low points in shingles are filled with sealant. Failure to properly seal could lead to water intrusion.

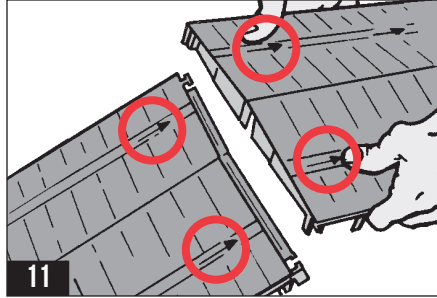

Always start with an Overlap end at bottom. Join vents together by interlocking the ends. REMEMBER: All arrows on all vents must point UP towards TOP of roof.

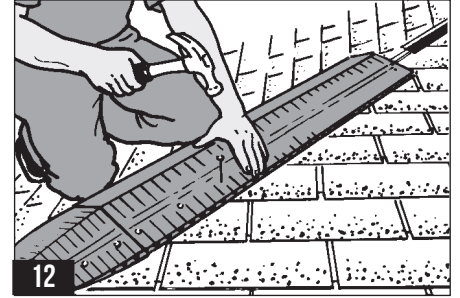

Make sure first vent is in place and begin nailing bosses, making sure nails penetrate at least 1/4" through sheathing. Refer to Step 13 for nailing sequence.

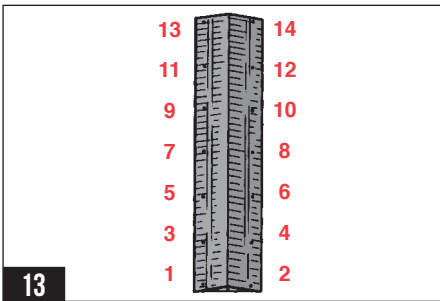

Recommended nailing sequence is from bottom to top of HipMaster and roof as indicated, alternating sides and nailing completely as you go up roof.

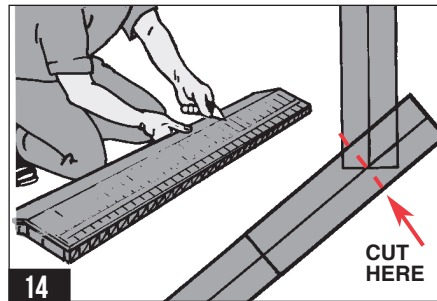

When hip and ridge vent intersect together, follow this method. Lay last piece of hip vent over top of ridge vent, measure where center of hip vent crosses center of ridge vent and cut hip vent square at this point.

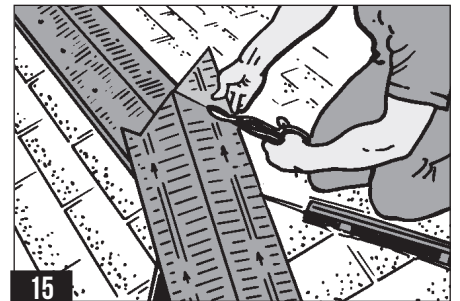

Carefully cut the HipMaster to conform with the ridge.

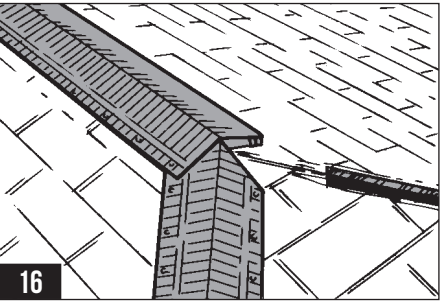

After applying roof sealant as in Step 8, lay down HipMaster and nail in place.

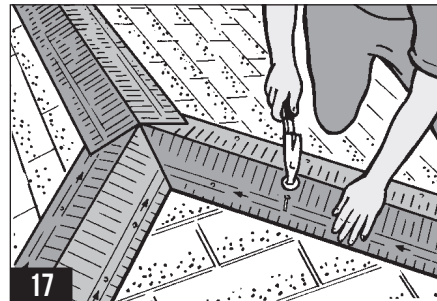

Repeat for other side. A tight mitre should result. If mitre is slightly open it should be sealed with roofing sealant.

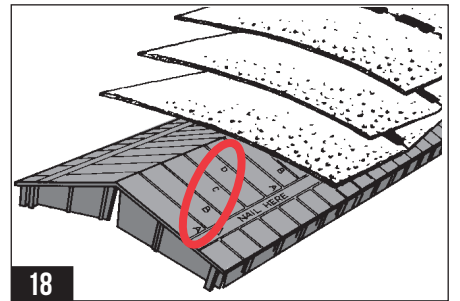

Use built-in Shingle Alignment Guides to evenly space cap shingles on HipMaster.

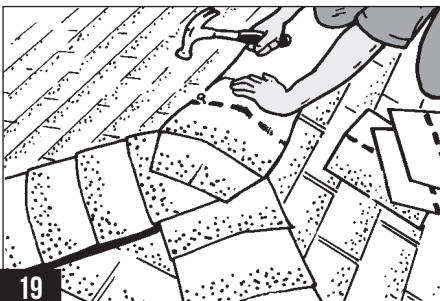

Nail all cap shingles in place working from bottom of hips to top of ridge. Finish by capping ridge. Apply a bit of roof sealant to last shingle where needed.

Special Applications of RidgeMaster Plus and HipMaster

For Residential, Commercial, New Construction or Reroofing

The following diagrams are intended as a general overview only.

METAL ROOFING

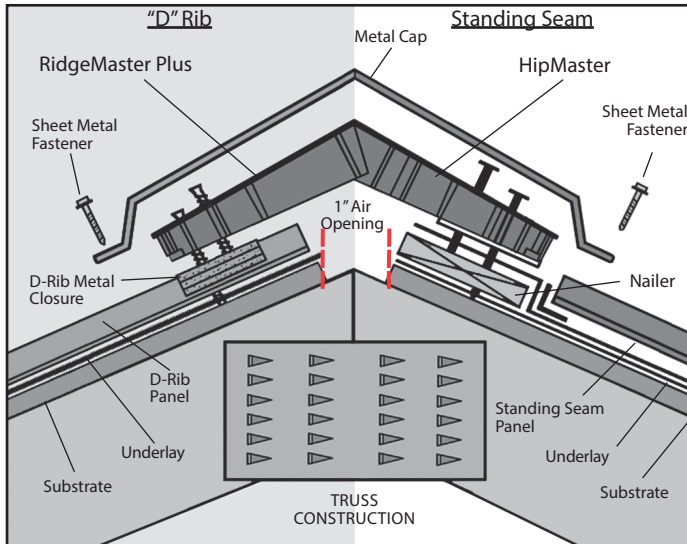

Use RidgeMaster Plus or HipMaster.
For use with D-rib or standing seam roofs.
Adapts to ridge pole or truss construction.

SLATE ROOFING

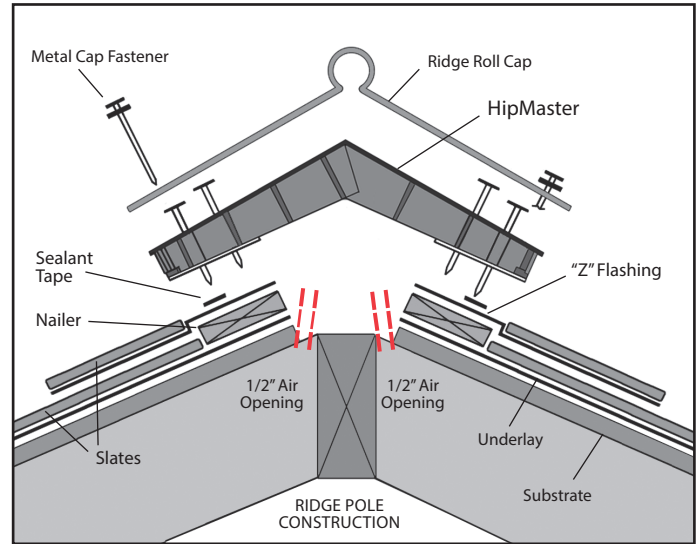

Use HipMaster.
For use with standard and textural slates.
Adapts to ridge pole or truss construction.

WOOD SHINGLE ROOFING

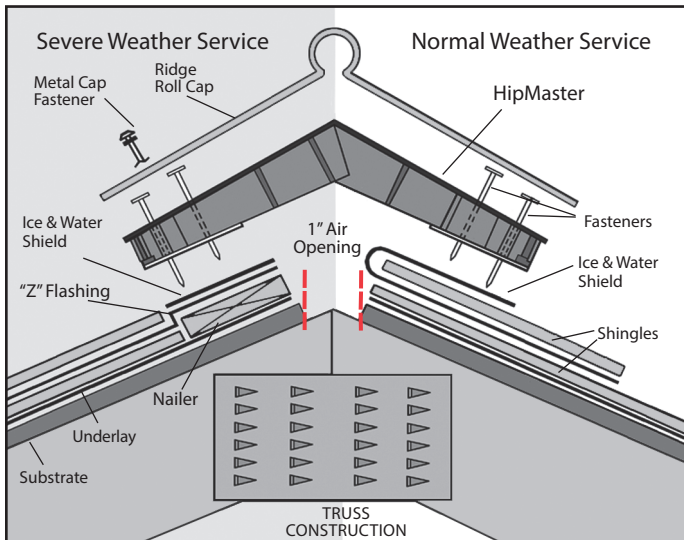

Use HipMaster.
Can be used with cedar shingles.

LAMINATE/WIDE BEAM

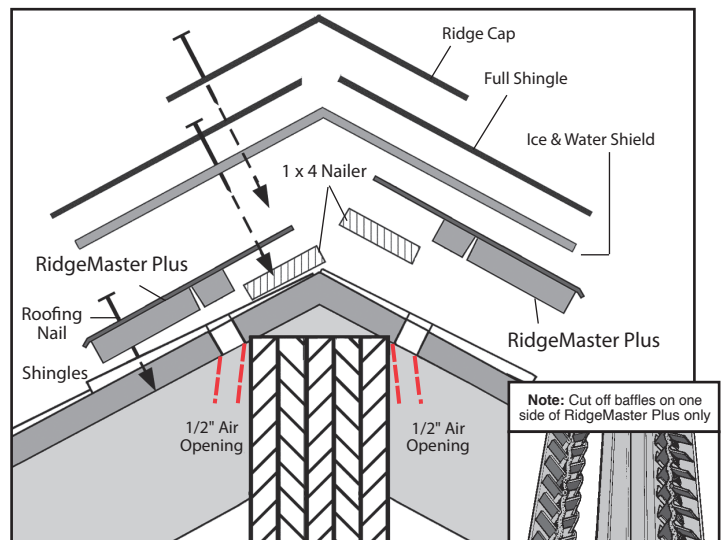

Use RidgeMaster Plus.
To be used for wide ridge beams as often found in cathedral ceilings, firewalls, etc.
Remove baffles and end pieces from one side of RidgeMaster Plus (see inset at right).

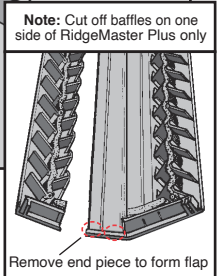

SHED/BASE VENT

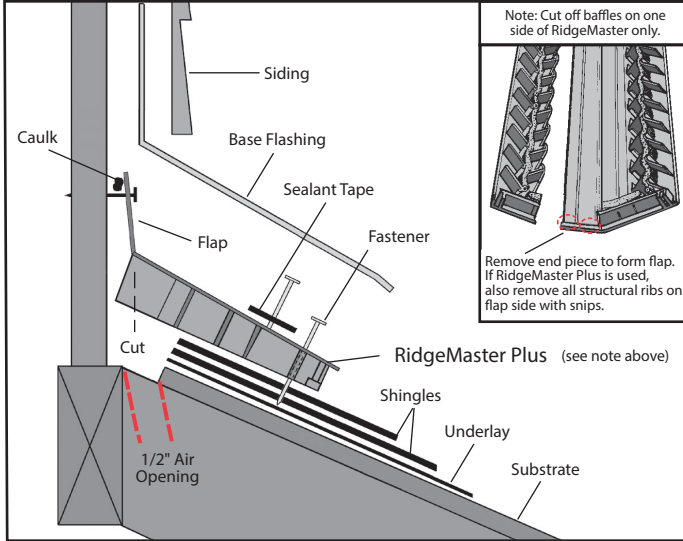

Use or RidgeMaster Plus and cut off baffles on one side to form flap. See inset above right. Used wherever a roof meets a wall: porch roofs, etc.

FASCIA VENTING

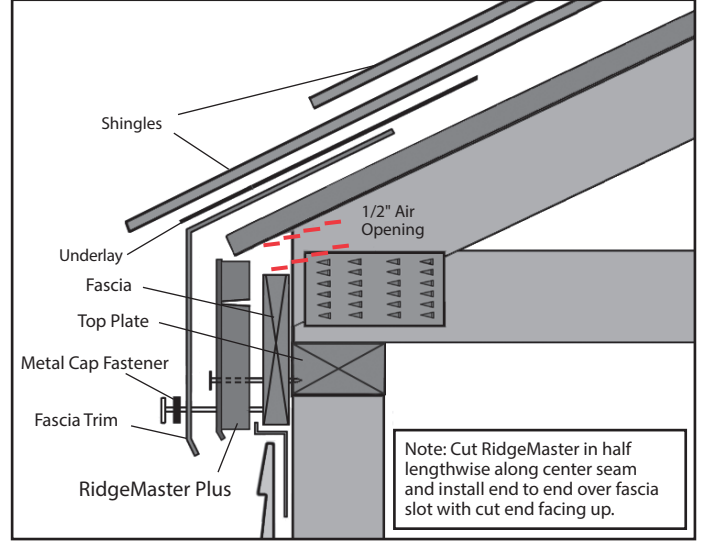

Use RidgeMaster Plus cut in half lengthwise. Great for homes with no soffit overhang. Does not interfere with installation of gutter. For new construction or retrofit. N.F.V. = 6.5 sq. in. per lineal foot.

CapMaster®

Protects and beautifies your roof, ends stack leaks forever!

- Dual wall construction slips in and over roof vent pipes ensuring that water is directed down the drain or onto sealed shingles. Fits all 3" and 4" vent pipes.
- Easily adapts to all roof pitches from 3-12 to 12-12. Only tools needed are scissors or snips to follow imprinted pattern for any pitch. Four colors to complement any roof: Light grey, dark grey, brown and black to beautify your roofs appearance.
- Mid-America's proprietary color molded throughout process resists fading, denting or chipping.

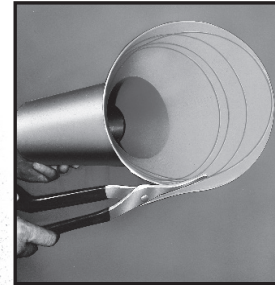
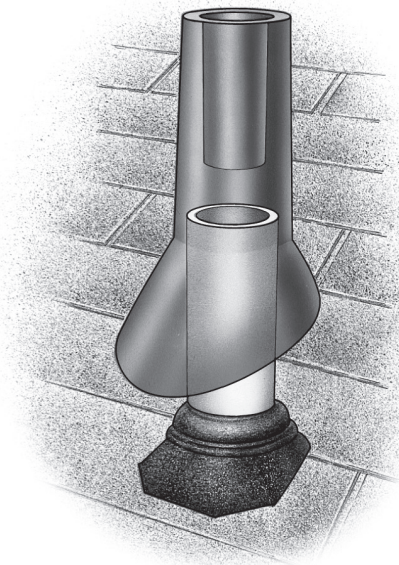

1. Using guideline on base, snip to your correct pitch.



2. Place CapMaster over pipe and rotate to proper angle. Friction clips hold it in place.



MidAmericaComponents.com

800-521-8486

Westlake
Royal Building Products™
WestlakeRoyalBuildingProducts.com

SIDING & ACCESSORIES
TRIM & MOULDINGS
ROOFING
STONE
WINDOWS
OUTDOOR LIVING